

Variotherm  
tested in  
practice.

Practical and thorough! 2-3

References 4-10

Product news 2014 11-13

NEW HD videos 14

P:UR news 16





Working reliably for the past 35 years.

"We have the best systems. Everything is included." – We're sure you have heard this promise from many manufacturers. And even from us. But there is a small, but critical difference: our systems work! Down to the smallest detail.

Tens of thousands of customers. Virtually no complaints. So many satisfied customers simply can't be wrong. Why is that? In part, because we have adapted our products gradually to meet real practical requirements over decades. We are individual in how we develop our products and our local consulting services.

We have a system for that, too. What is the point of the industry designing products that are really pretty good but abandoning the craftspeople when it comes to installation? We believe that a manufacturer's responsibility does not end when its product is delivered; that is when it really starts. When we deliver individual parts, which are assembled to a system on-site, we include the security of optimal support for our customers.

Experience has shown that clear and straightforward steps guarantee successful installation. We want craftspeople to keep their promises to the customer. So we support them with more and more fresh and practical ideas, which we integrate in our systems and services. The following pages provide you with details of the latest product innovations and sustainability approaches so you can see what we are talking about. You can count on it.

Kind regards,  
Alexander Watzek



# Practical and thorough!

**Never-ending attention to detail. This approach has driven us to continue development for decades, because we know that every big thing started out small. And it is the small things that really make life worth living.**

All screws are not built equal. That's a fact, no matter which way you turn it. Of course, many manufacturers offer a wide range of plasterboard screws on the market. However, anyone who uses the included genuine Variotherm Fermacell screws can be absolutely certain that they will never find a rusty bloom on their walls. They are effortless to screw into the supporting structure. Besides, our screws are completely flush with the board surface. That automatically reduces the subsequent smoothing work. Simply sophisticated.

That is just a small example of how we think all of our components, tools, small items and assembly aids through thoroughly, before we hand them over to our customers.

We test every part we deliver for practicality in our premises before delivery. We also commission independent institutes to test our products. As a result, we are familiar with even the tiniest parts of our system, and there is nothing our support teams do not know. We answer every detailed question with a solution. Everything we recommend and deliver works in practice. A promise kept!

## The Variotherm workflow

- 1 The direct route to a Variotherm professional partner**  
You have decided to build a new house, refurbish one gently or reconstruct it fully. But which are the most suitable energy saving heating and cooling systems for the project? Building owners should go straight to their installer, or better yet to their Variotherm professional partner. They know all about our products and can find the right solution immediately.
- 2 Professional plans from architects and construction managers**  
Architects and construction managers take a professional approach to producing plans. They focus on design, energy and cost efficiency – values which are in perfect harmony with the Variotherm systems. Both our professional partners as well as architects and construction managers trust the expertise of Variotherm's professional planners when it comes to drawing up detailed plans.
- 3 Variotherm professional planners**  
Our technical team processes roughly 1,600 projects every year with optimal planning and consulting – expertly and individually.
- 4 Expert installation by professionals**  
Everything is planned and implemented perfectly. The system is fitted by an expert installer. With comprehensive support, Variotherm helps ensure that every question is answered. Training on the construction site is a key part of the Variotherm service.



Look closely at the product details!

It is the details that make a product perfect. So it's a good thing that Variotherm's developers are so attentive to detail! These are some examples of how important reliability, simplicity, flexibility and practicality are to us:

### \_Profiled VarioProFile pipe

The 5-layer composite pipes developed by Variotherm have a larger surface (10% to 15%) than comparable pipes. Their profiled structure ensures optimal heat transfer. The interior laser-welded aluminium pipe has an extremely stable form yet remains easy to bend.

### \_VarioBar with click technology

VarioBar 11.6 or 16 for the system or EasyFlex wall heating/cooling systems and the VarioRast floor heating system can be shortened every 100 mm without tools. The click technology means that rails can be extended to any length in 500 mm steps.

### \_Variable ModulePanels

All constructive requirements can be fulfilled with just 8 different ModulePanels. On request, we can manufacture individual ModulePanels with custom dimensions and pipe assignments. That is a huge advantage, in particular for listed buildings or extremely unusual design requests.

### \_Prefabricated template holes

All ModulePanels have finished marked template holes. They show the exact screw position and effectively prevent screws penetrating the pipes. With this positive feeling of security, installers can complete assembly quickly.

### \_Special compact filling compound

Pour, smooth, and you're done. That's how easy it is to fill the pre-laid VarioComp floor heating system for drywall construction. Floor coverings can be applied after a short drying period of 24 hours or more.

### \_Mixing bucket with visible markings

For perfect mixing of the compact filling compound, the 30 litre bucket with clearly visible markings for the correct water level is recommended. Further evidence that extremely simple, practical ideas often make work easier right away.

### \_Precise installation instructions

All systems include detailed descriptions and illustrated installation steps. They are easy to understand and can be followed simply in the field.

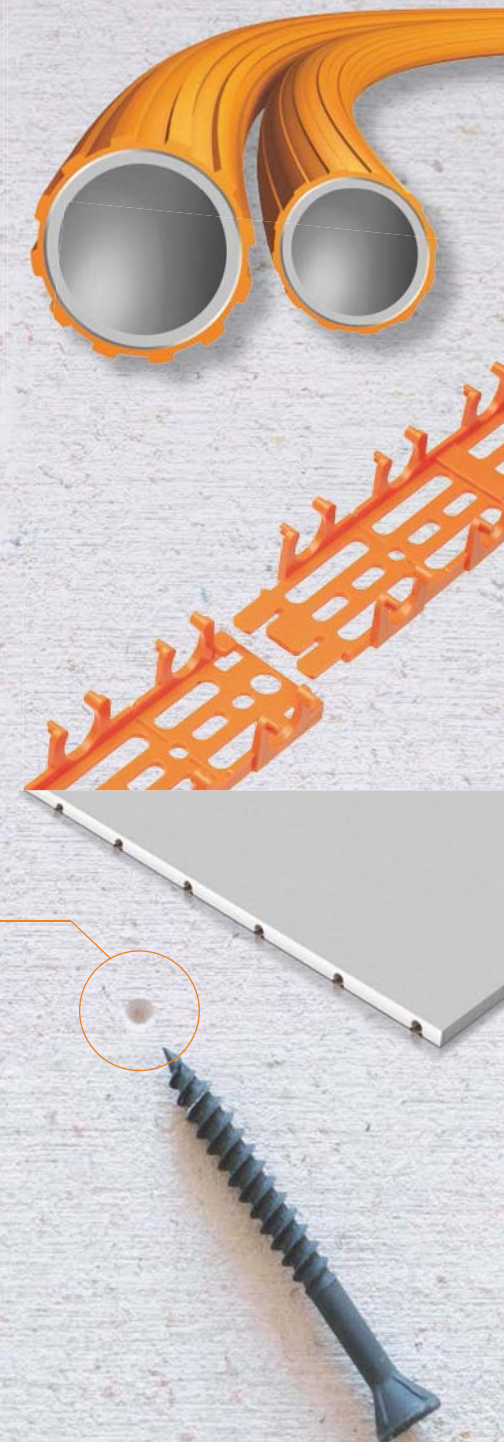
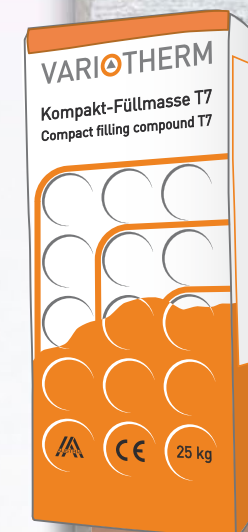
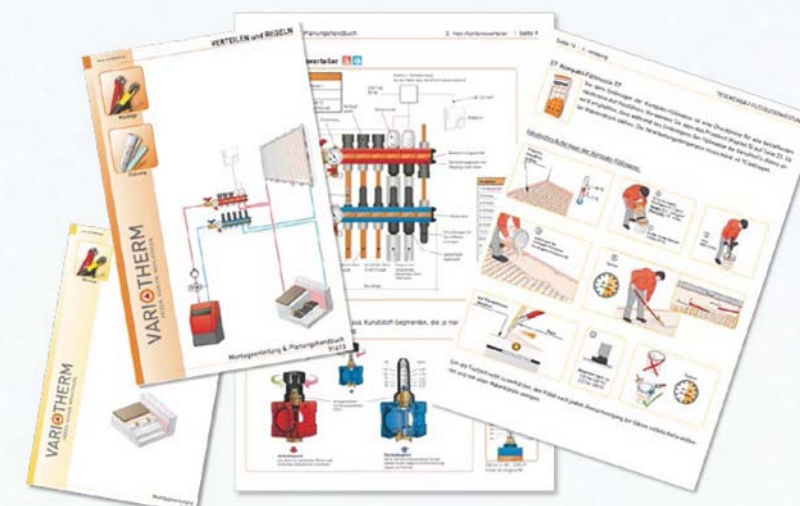





# Practical test by designers

The venerable old building of the former branch of the Austrian National Bank in Eisenstadt can look back on an eventful history. Built in 1924 in Art Deco style, it forms an architectural contrast to Esterházy Palace opposite, and is currently listed for preservation.

On the name plate on the second floor, there is a small panel with the name "Studio Häc-Mäc". It is home to the advertising agency which has represented us since 1996. There is probably no-one who knows the benefits of the Variotherm surface heating and cooling systems better than the graphic design team of Reinhard Gombas and Jürgen Zwingl.

For the last 50 years, the building was heated with a monstrous oil heating system. In the end, it was high time for a new heating system. One of the most important requirements of the Department for the Protection of Historic Buildings was that the studio's 170 m<sup>2</sup> original oak parquet floor from the 1920s must remain intact.

"We wanted a solution that would add value for the premises in the long term. That is why we chose an air heating pump combined with a ModuleStandardWall for heating and cooling," explained the two designers. Another pleasant side-effect was that the old radiators vanished from the studio. Besides the aesthetically appealing design, the expected savings in heating costs were of course a key criterion.

The closure of the office was to be as short as possible. In cooperation with an experienced drywall construction expert, the entire project was implemented in just 10 days. The renovation was coordinated by Peter Unterrainer (Variotherm). The heating distribution manifold was set up and the heat pump was connected by a specialist installation company.

The test results: "During the construction work, we rolled up our sleeves ourselves and pitched in. It was an interesting experience for us to see how perfectly the individual Variotherm components combined to form an easy-to-install system. It is a good feeling to make advertisements for a company whose products you find so impressive."



- 1 Large heating and cooling surfaces in the foyer and meeting room  
ModulePanels installed with supply lines from above. Individual adaptation for corners and niches without much chiselling work.
- 2 Easy installation in the WC  
The ModulePanel was installed horizontally there.
- 3 The ModulePanels were installed at a height of 60 cm before the bookshelves in the office  
Heating and cooling at an ideal height.
- 4 ModulePanels laid with ornamental strips and flush cable duct  
Ornamental strips were used for doors and windows to match the Art Deco style of the rooms. The cable duct which previously protruded from the wall was laid flush with the ModuleWall.
- 5 In place of an old radiator, there are now radiation walls in office 2.  
ModuleWalls on the external walls and surrounding the door. The cable duct was also used here to install the supply lines of the ModulePanels without complex chiselling work.
- 6 Heat pump  
Heating and cooling can be this easy.

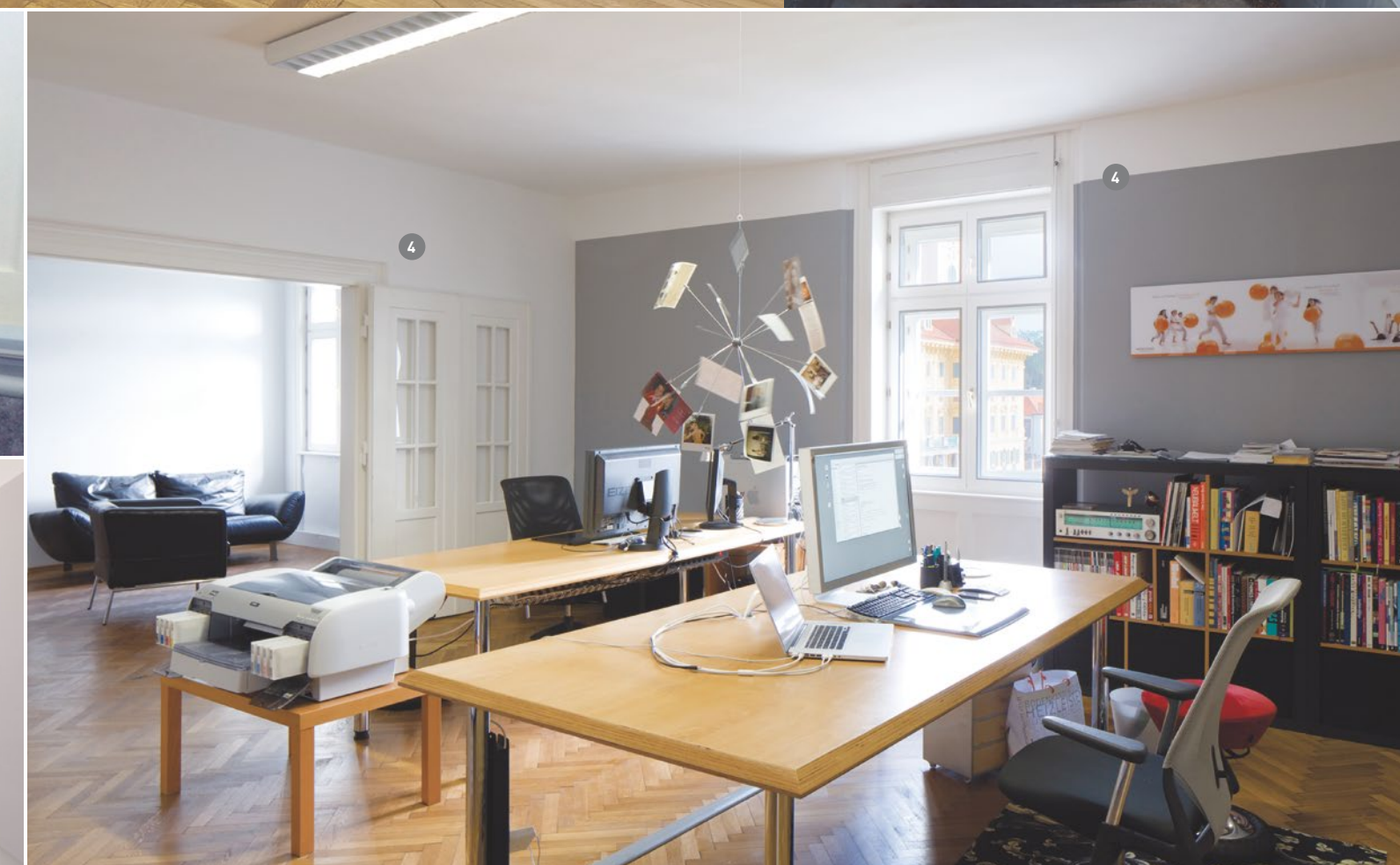

## TECHNOLOGY ModuleStandardWall Heating/Cooling

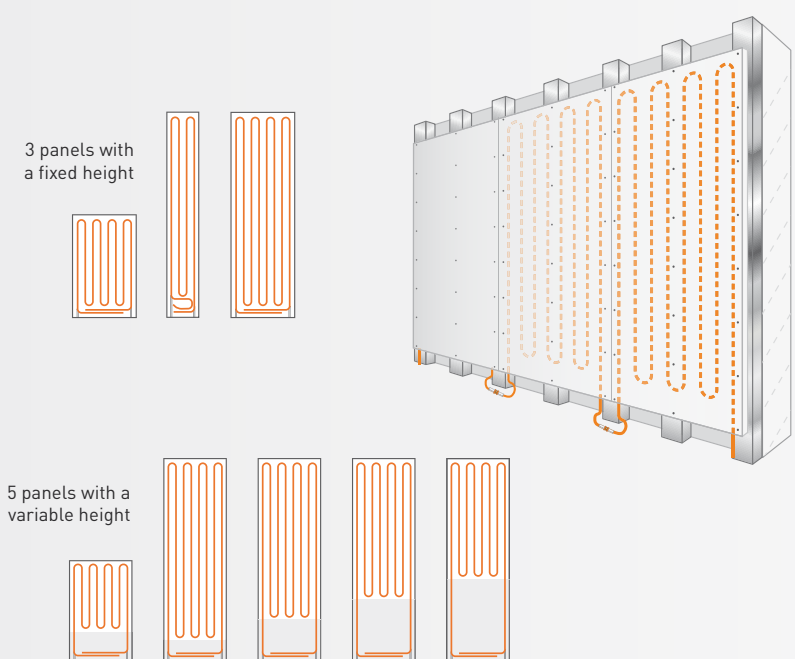

### Studio Häc-Mäc Eisenstadt

#### Installers

Ewald Janska, AT-7201 Neudörfel  
CLEEN Solair, AT-7062 St.Margarethen  
www.cleen.at

#### Drywall system

Helmut Hirschler  
AT-2493 Lichtenwörth  
www.hhdesign.at

#### Variotherm systems

80 m<sup>2</sup> MODULE WALL HEATING/COOLING

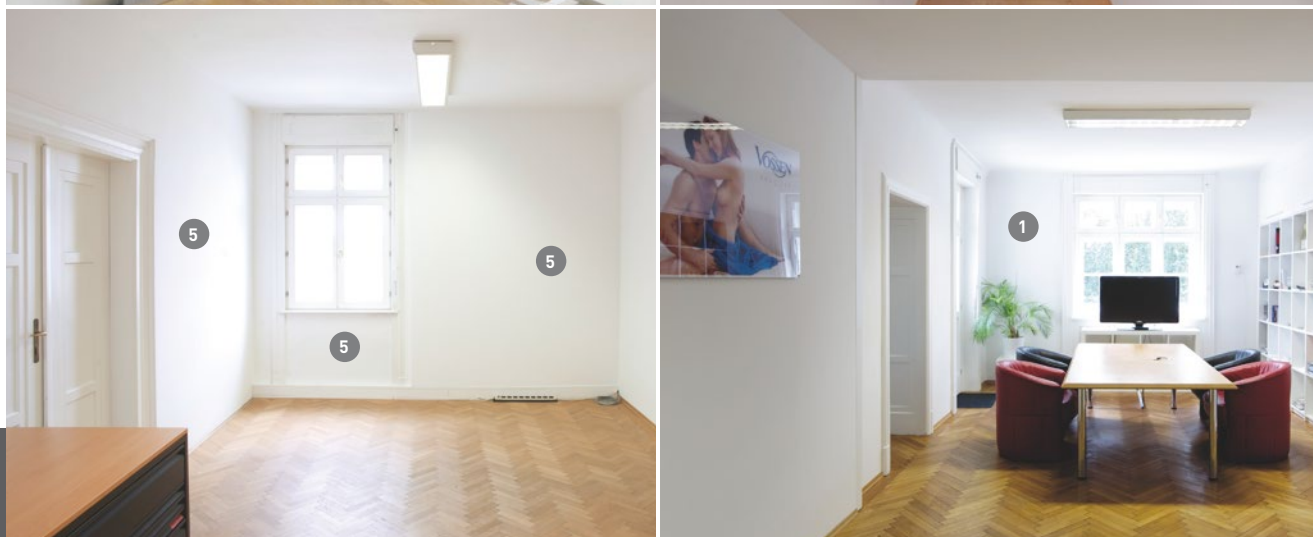



# A beautiful view. For the far-sighted.

And off we go! The suspended railway lifts off over the gentle slopes of the Elbe Valley in the beautiful city of Dresden. It is the oldest railway of its kind in the world, and its terminus is the timeless SCHÖNE AUSSICHT (BEAUTIFUL VIEW).

A peaceful, relaxing place, with an extremely pleasant atmosphere that refreshes the senses. Anyone who fancies a journey through time will feel at home in the SCHÖNE AUSSICHT Restaurant & Hotel. Of course, the atmosphere has changed over the company's 160-year history. However, the elegance of the Golden Twenties still shows through and enriches the entire ensemble today.

However, for a time, it seemed that the historic building would fall into ruin. It took four friends who came together in 2012 to restore SCHÖNE AUSSICHT again to what it had been for many decades: a cosy retreat with

a great view of the city.

The completely refurbished hotel and restaurant's open design impresses with its generous proportions and lightness. Clear structures and a modern wall decor create transparency in which white and black dominate. The entire glass façade opens to the terrace, adding even more light and expansiveness.

No question: this is a successful complete refurbishment in every way. With its superslim panel thickness of just 20 mm, the VarioComp floor heating was the ideal choice for this gentle renovation project. Here, a historic atmosphere meets a tangible sense of well-being with intelligently integrated heating technology. Now SCHÖNE AUSSICHT's beautiful panorama has been supplemented with the outlook of low energy costs. Splendid!



TECHNOLOGY VarioComp floor heating

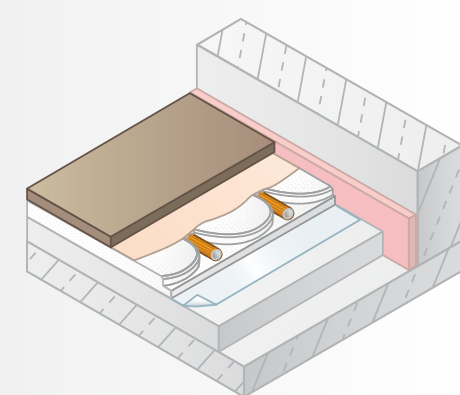

- VarioComp
- 1 Substructure
- 2 Compact panel 600 x 1000 mm
- 3 VarioProFile pipe 11.6 x 1.5 mm Laser
- 4 Compact filling compound
- 5 Floor covering

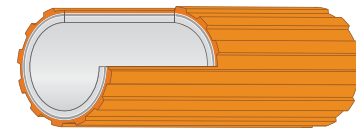
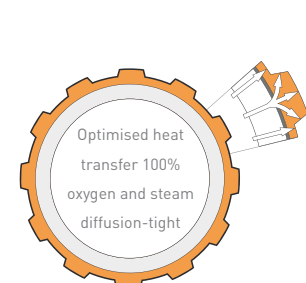

**VarioProFile pipe 11.6 x 1.5 mm Laser**  
5-layer composite pipe  
**Only available from Variotherm:** interior aluminium laserpipe – giving it an extremely stable form while remaining easy to bend. Profiled surface!

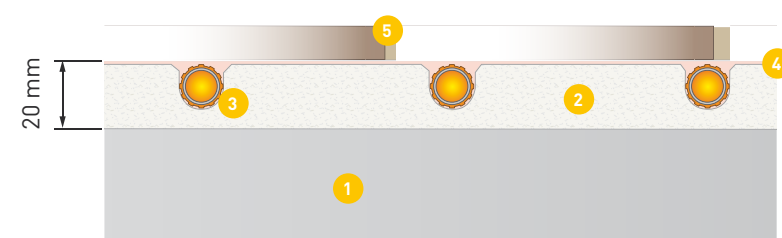

Hotel Schöne Aussicht

**Construction management**  
Architect Thomas Oliver  
DE-01904 Neukirchen  
[www.architektur-thomas.de](http://www.architektur-thomas.de)

**Installer**  
Haustechnik Just  
DE-01877 Demitz-Thumitz  
[www.bad-heizung-just.de](http://www.bad-heizung-just.de)

**Variotherm systems**  
200 m² VARIOCOMP FLOOR HEATING

# Snip ... and things heat up!

Expert fingertips massage your scalp silently but purposefully. A gentle stream of hot water makes its way through the foamy shampoo crown. That's how we know and love our trusted hairdresser. If there weren't the constantly repeated question when rinsing out the silky sheen conditioner: "Is the temperature OK?"

Of course, you always answer: "Yes ... it's fine." But what if that isn't the case? What if the air in the salon is too hot and steamy? Or a blast of cold air blows around your legs every time someone opens the door?

Every modern salon needs a suitable heating system. Hairdresser Karin Bräuer had just this problem when setting up her trendy salon in the German town of Horka. There was no room for radiators on the walls, and there was no way to install floor heating, no matter how slim the system. It was enough to make you want to pull out your hair.

Luckily the Hähnichen-based heating and sanitation specialist Peter Reinhold knew of two suitable solutions right away. The radiator space problem was solved with a convenient and invisible Variotherm wall heating system. And the large-area Variotherm ceiling heating system proved a real saviour. It spreads heat wonderfully evenly throughout the room. It was lowered around the edges of the ceiling to allow indirect lighting to be fitted. So the redesign not only fulfilled every architectural need, it also made it possible to create cool hairstyles.



TECHNOLOGY ModuleStandardCeiling-Classic ModuleStandardWall

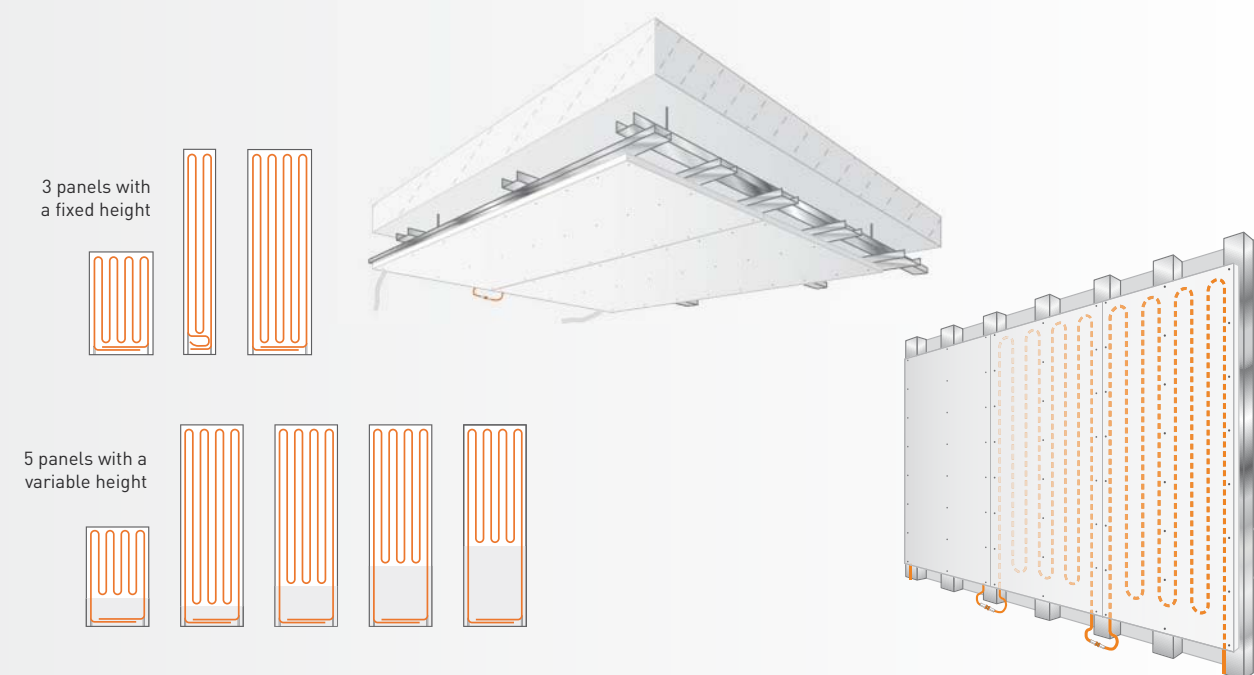

Salon Karin Bräuer

**Variotherm dealer**  
Andreas Ackermann  
DE-01561 Großenhain  
[www.variotherm-sachsen.de](http://www.variotherm-sachsen.de)

**Installer**  
Sanitär/Heizung Peter Reinhold  
DE-02923 Hähnichen

**Variotherm systems**  
15 m² MODULE WALL HEATING  
71 m² MODULE STANDARD CEILING - CLASSIC



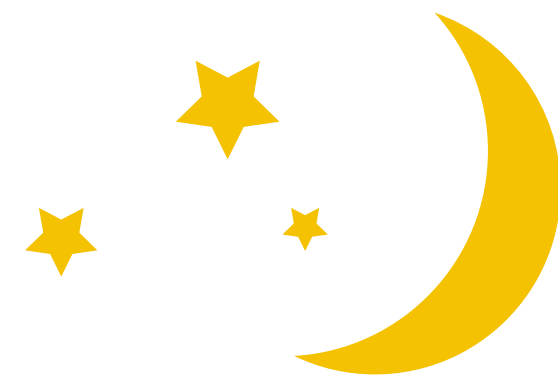

# To the moon in children's shoes

Children love to play on the ground. It's convenient. The staff at Bad Vöslau kindergarten thinks so, too. The colourful sign on the entrance reads Sunflower Alley 4. The children who kiss their mothers before they hop over the threshold to play happily with their friends here are just as sunny as the sign.

"For children, furniture is not that important," reports Maria Jezek, the kindergarten principal, from her experience. Sitting still on a chair for a long time? Uncomfortable! The play areas on the floor are much cosier! And the children make the most of them, especially because they are so nice and warm. The fact that the space is fitted

with a VarioRoll floor heating system is part of a superordinate green building concept. The environmentally-friendly ECO kindergarten offers 1,155 m<sup>2</sup> of usable area and 3,000 m<sup>2</sup> of outdoor play area. The floor coverings chosen had to be absolutely free of harmful substances. Breathable climate-friendly plasterwork was also used.

However, the roof garden is the real highlight for the kids. After all, who hasn't dreamed of living in a cosy hobbit hole – with grass, moss and flowers on top?



In the Bad Vöslau kindergarten, the staff clearly wants to educate the children to develop a sustainable approach to nature and the environment. And the parents are involved in this process too. "We want the children to eat healthily, so we buy and prepare the food with them. We also have two raised plant-beds where we grow our own herbs. If possible, the children are encouraged to walk to the kindergarten. That way, they earn lots of green miles," says the principal. Green miles? Exactly! As a Climate Alliance municipality, Bad

Vöslau participates in this global programme for environmentally-friendly forms of mobility. In this way, they have already walked to the moon. The next step is a mission to Mars.



## TECHNOLOGY VarioRoll floor heating system

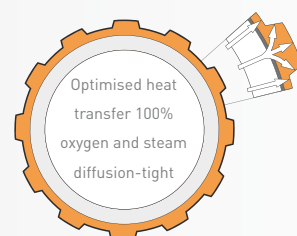
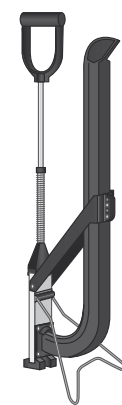
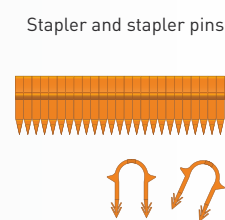
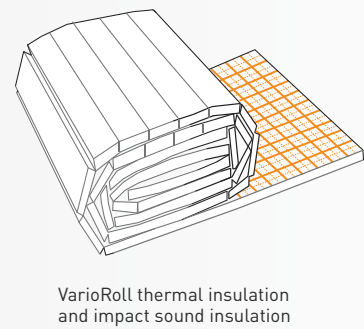
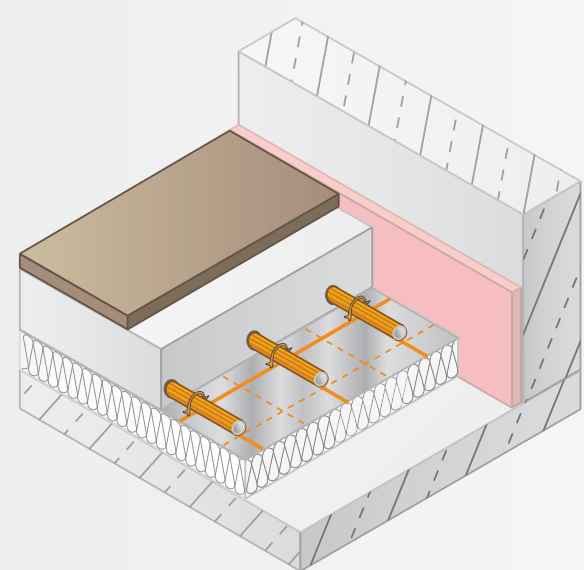

VarioProFile pipe 16 x 2 Laser  
5-layer composite pipe  
**Only available from Variotherm:** interior aluminium laserpipe – giving it an extremely stable form while remaining easy to bend. Profiled surface!

### Kindergarten Bad Vöslau

Planning/design and construction management:  
Kosaplan  
AT-2544 Leobersdorf  
www.kosaplan.at

Installer  
Pluy GmbH  
AT-2540 Bad Vöslau  
www.pluy.at

Variotherm systems  
860 m<sup>2</sup> VARIOROLL FLOOR HEATING





## Sensational steel

The 360 experts at the leading German steel construction and façade technology company Züblin Stahlbau GmbH are used to thinking big. They set high standards for first-class products and professional services from a single source for efficient construction. So the connection to Variotherm was clear.

Züblin Stahlbau GmbH's innovative steel, aluminium and glass façades reflect a cosmopolitan approach, deep respect for other cultures and a highly developed appreciation of intelligent system solutions. The company's long list of references include power stations, production and industrial plants all over the world.

Versatility, compliance with international standards, utmost quality and reliability are the founding principles of Züblin Stahlbau GmbH. The standards for the products and materials to be used when designing the company's own building in Hosena, Germany, were similarly high.

The decision to use the Variotherm ModuleStandardCeiling-Classic and the ModuleStandardCeiling-Acoustic as the ceiling cooling/heating systems was unanimous. Even unusual design requests of the architect Andreas Stenske could be implemented perfectly with the 8 module panel dimensions available. The company prizes maximum efficiency in using the space available. The Variotherm ModuleStandardCeilings also fulfilled this decision criterion perfectly.

When devising its complex projects, many of the Züblin Stahlbau GmbH team often sit together for hours. As a result, the company chose a sound-insulating ceiling cooling system to equip the meeting rooms. This reduces the noise-based stress, and improves performance and concentration during planning meetings. That ensures that the Züblin Stahlbau GmbH team also keeps a cool head even on steely working days.



## NEW: The VarioSolid industrial floor heating system

Cost-effectiveness is always an issue when it comes to heating production halls, storage areas and other industrial spaces. An extremely solid and universal solution to this is VarioSolid, the industrial floor heating system. Specially designed for use in industry, the extremely robust Variomodular pipe 20x2 Laser ensures ideal heat distribution.

With the professional battery powered binding tool, Variotherm combines innovation with highly ergonomic and rapid installation. It can be ordered directly from Variotherm or rented at low rates (in Austria only).

With the VarioSolid industrial floor heating system, Variotherm rounds off its varied product range in the floor heating system sector. A healthy working environment meets efficient heating at a high level.



### Professional battery powered binding tool

The professional wireless binding tool lends itself to quickly fastening the Variomodular pipe to the reinforcing bar grid. Place in position, press a button and 80 cm of binding wire per spool create a lasting bond. A wire reel contains enough for approximately 120 bonds. The optional extension arm permits an ergonomic assembly when standing.



Variomodular pipe 20x2 Laser with proven Variotherm pipe technology



New single-part clamping screw fitting 20x2



Sleeve tube for movement joints



Calibration and chamfering tool



Bending model for 200 mm, 250 mm and 300 mm pipe spacing

TECHNOLOGY

ModuleStandardCeiling-Classic

ModuleStandardCeiling-Acoustic

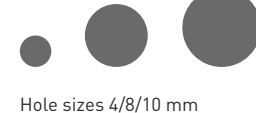
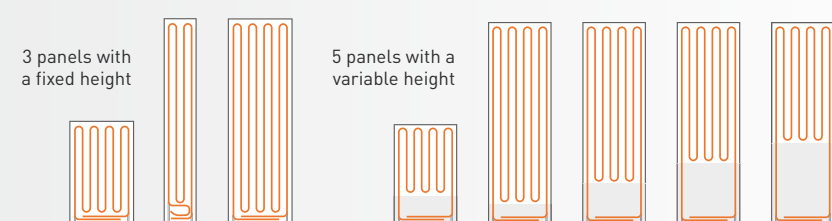
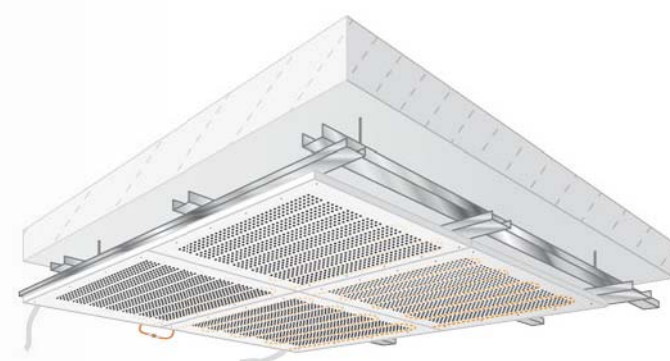
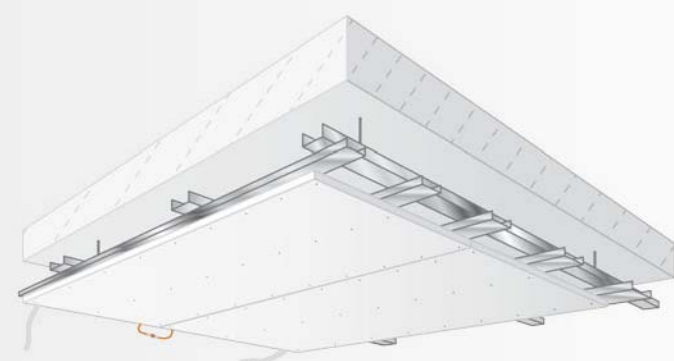

Hole sizes 4/8/10 mm

### Züblin Stahlbau

Planning/design and construction management  
Architekt Andreas Stenske  
DE-02994 Bernsdorf

Installer  
Retschke-Zschornak GmbH  
DE-02627 Radibor  
www.rz-camina.de

Variotherm systems  
600 m<sup>2</sup> MODULE STANDARD CEILING - CLASSIC  
30 m<sup>2</sup> MODULE STANDARD CEILING - ACOUSTIC



# 7 brilliant new products

Quality is no coincidence! It is the goal of daily efforts to make something good better. The new products for 2014 required long research, development, testing, selection and surveying phases before the release. The result is impressive – in no less than seven ways:



## Fermacell greenline joint adhesive

The new biological greenline joint adhesive binds our Variotherm module panels like casein glue. It protects the environment and our health. The adhesive is viscoplastic once set. It can be used and worked on just like its predecessor. The Fermacell greenline joint adhesive has also been approved for the construction of prefabricated houses in the workshop.



## Elbow fitting 6/4" 90°

Right angle. Easier installation. It's as simple as that! The elbow fitting has a full bore and it serves to guide vertical supply lines to the Variotherm heating/cooling distribution manifold.

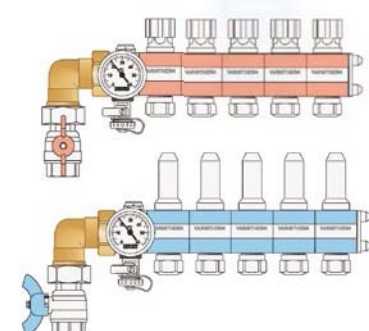

## Cold shrink tape

The durable Variotherm cold shrink tape protects press-fit couplings optimally against corrosion. Complies with ÖN H5155.



## Calibration and chamfering tool

ONE tool for ALL Variotherm pipes! That makes calibration and chamfering child's play.



That's how the others do it... and this is how Variotherm does it!

## Clamping screw fittings with system

Insert the pipe, fix in position, done. The new clamping screw fitting for the VarioProFile pipes 11.6x1.5 and 16x2 consists of one single part. So no more small parts can go missing. Handy! AND: Thanks to the clamping technology with metal ring developed by Variotherm, the new clamping screw fitting, which has been tested under EN 21003, is even better value.



## Electronic room thermostat PIANO HK-Funk

It's funky! The best controllable room temperature without an electrical installation! For both heating and cooling. The battery-operated room thermostat PIANO HK-Funk features a wireless set consisting of a single-channel sender and receiver. Simply set it up and the PIANO HK-Funk will be ready for use thanks to its factory-programmed radio transmission. Funky and easy!



## Super-economical thermoelectric actuators

100% output. 1 watt consumption. We call that super-economical. The new thermoelectric actuators use far less power than their predecessors. The design was also overhauled and it is now available in new colours.

# The new products have a lot to offer!

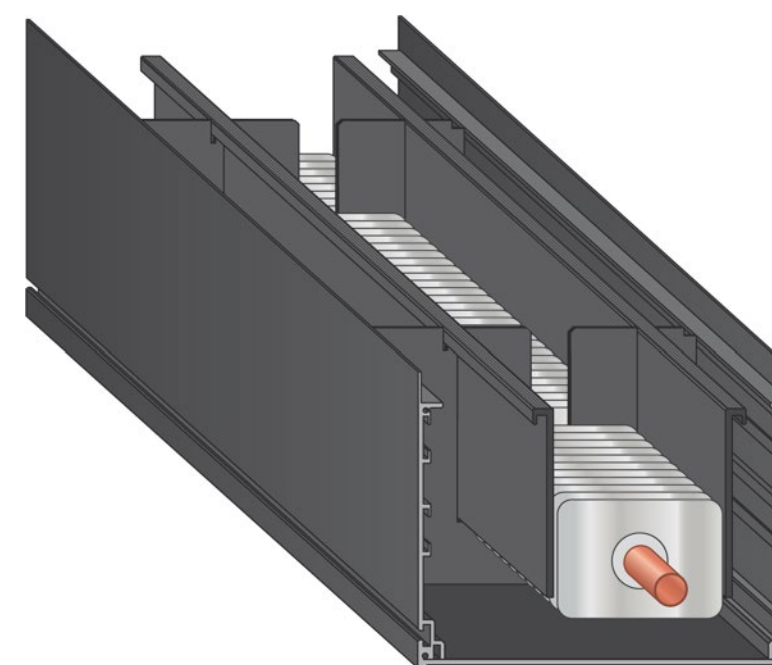

A whole new duct design. Innovative air routing. Refreshing grid variants. That makes the new 2014 Variotherm ducted channel heating system special.

The new design makes the full duct width available for an optimal air routing.

Ingenious! The ducted channel can now be aligned precisely for the floor level with the interior adjustment screws.

The improvement of the system has another positive effect: the price has been reduced significantly!

- Compact aluminium profile tray
- Linear grid and rolled grid
- Precise height adjustment with interior adjustment screws
- Available in 2 different heights: 90 mm and 140 mm
- Improved air routing with 2 air baffles
- With proven Variotherm heating element
- Short lead times
- Price advantage

All grids are available in six refreshing colours.

- Plain aluminium
- Light brass
- Brass
- Light bronze
- Dark bronze
- Black

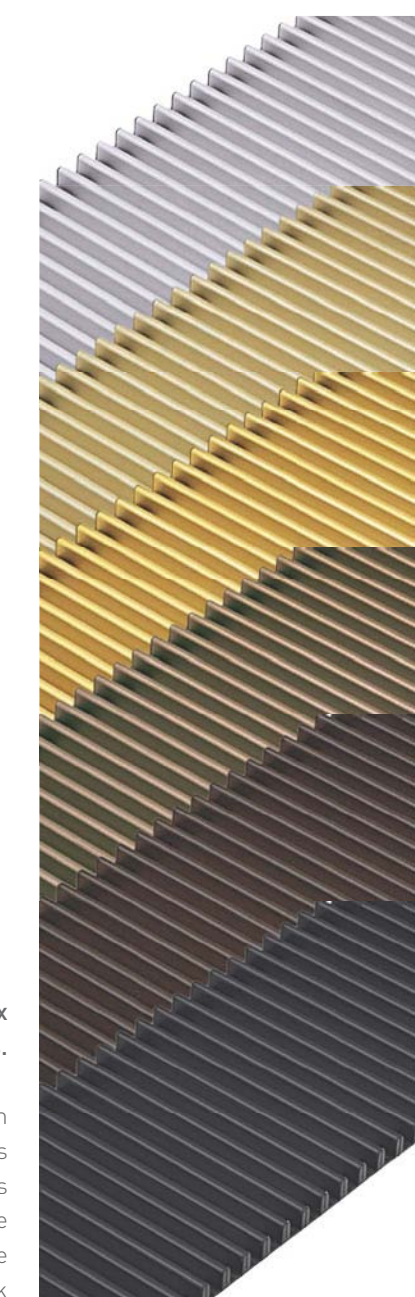

Typ BKH1 mini

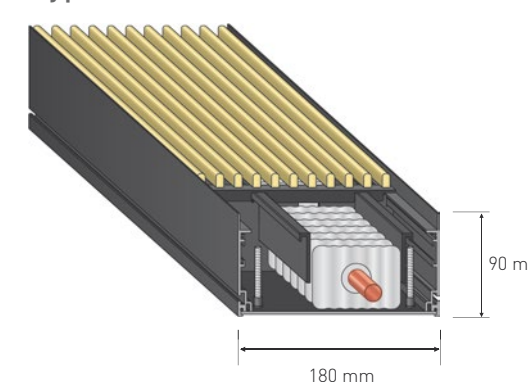

Typ BKH2 mini

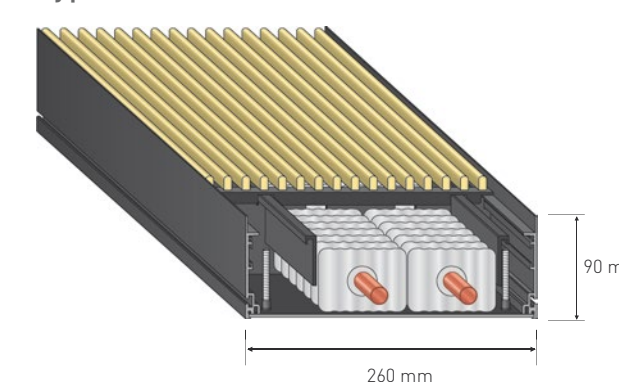

Typ BKH1

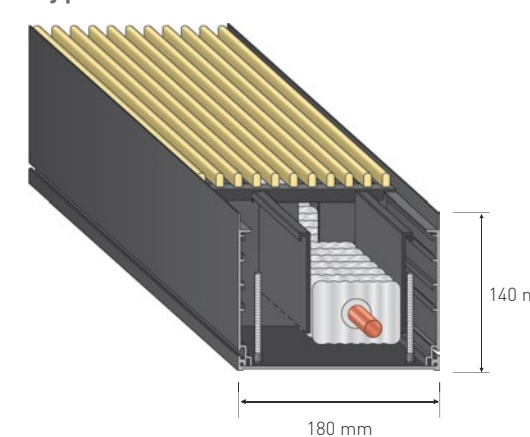

Typ BKH2

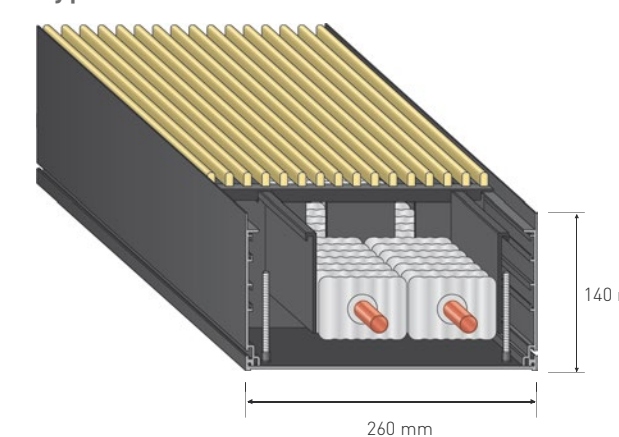

## Robust adjustment. Without underfilling.

Another feature of the new ducted channel heating systems are the adjustment screws for weight-bearing installation. That means that underfilling is not necessary. The elements are accessible immediately after installation.

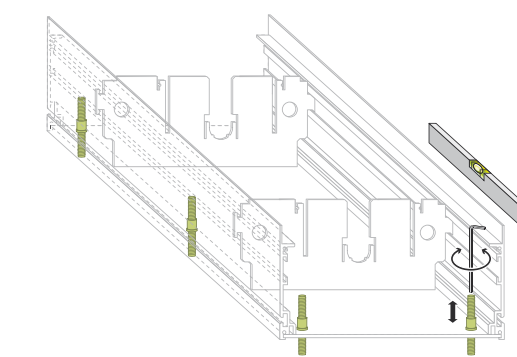

## New and easy-care

The new rolled grid can be rolled up conveniently. Clean and extremely practical!

## Classic, tried and trusted

The linear grid is our top seller. Aesthetically pleasing, technically perfect!





# Worth watching: 6 new HD VIDEOS!

Brand new on your screen and really cool: the remake of our Variotherm product videos is a real hit series. In six episodes, the technical stars put on an impressive show both in German and the English original version.

Overheard recently in the gosh!audio sound studio: "How do your customers actually pronounce the name Variotherm in English?" asks professional voice actor Renate Prohaszka through the microphone in the recording room: "VAHriothurm or VAYriothurm?"



So we have to clarify a detail yet again! It's a good thing that, in addition to the Häc-Mäc team (video concept + graphics), Paul Szimák (editing + text), Fritz Dorfner (illustration + animation) and Bernadette Weissenböck (Variotherm Marketing), Variotherm boss Alexander Watzek attended the recordings in person to ensure things go smoothly.

The new, highly informative HD videos offer you an ideal concise overview of the main product features, advantages and use options of the Variotherm systems. And, as we are sure you also want to know which pronunciation we recommend, we suggest that you watch the six new Variotherm videos to find out!



ALL VIDEOS >>> [www.variotherm.at/video](http://www.variotherm.at/video)

- 1 FLOOR HEATING FOR DRYWALL CONSTRUCTION  
Super-slim for drywall construction!  
The ingenious compact floor heating system!
- 2 FLOOR HEATING FOR SCREED FLOORS  
4 brilliant floor heating systems! For every screed floor!
- 3 WALL HEATING/COOLING SYSTEMS FOR DRYWALL CONSTRUCTION  
Heating. Cooling. Wall. Ideal for dry-wall construction, attics and renovations!
- 4 WALL HEATING/COOLING SYSTEMS UNDER PLASTER  
The perfect wall heating and cooling systems for installation under plaster.
- 5 SKIRTING HEATING  
Individual skirting heating systems: perfect for beautifully designed living spaces.
- 6 CEILING COOLING/HEATING SYSTEMS FOR DRYWALL CONSTRUCTION  
Cooling and heating ceilings. With or without acoustics!

## Green oasis



"I'm off to fill up on energy!" ... That's what it sounds like sometimes when colleagues at Variotherm take their breaks. And it's true: the new and wonderfully sunny seating area in the garden really is very relaxing and cosy. The inviting larch wood terrace is surrounded by hornbeam trees and other native shrubs, and offers 800 m² of idyllic meadow vistas. Only a single building is planned in the lush green landscape: an attractive hotel for beneficial organisms and insects.

## Organic ☺catering

Susanne Kühn cooks for us. Fresh every Thursday. Sometimes delicious vegetarian dishes, and sometimes tasty fish. She is convinced that the secret of good taste is on the path between fields, water and the plate. And in this case, this path could not be shorter. For her organic, healthy and indulgent cuisine, Susanne Kühn uses the best Austrian ingredients from the local region. The fish comes straight from the neighbouring Gut Dornau fish farm: as the crow flies, the fish travels roughly 10°m from the pond to the pot. Dessert is Kühn's famous cream sandwich with home-made butter puff pastry. A dream.



TIP: Susanne Kühn cooks for her guests in the nostalgic Mühlsteinstube (Millstone Inn) in Leobersdorf. Book your table and enjoy your meal! [www.muehlsteinstube.at](http://www.muehlsteinstube.at)



Thomas Baumgartner, Herbert Holzbauer and Alexander Watzek

## 10 years of technology. 20 years of sales.

Thomas Baumgartner is the head of our technical department and is appreciated by all. For 10 years, he has shown an unmistakable touch in development and research, and done so with admirable endurance and detail. He brings innovations to market.

For 20 years, Herbert Holzbauer has been one of the untiring driving forces at Variotherm – whether in his position as head of sales or authorised officer. Individually and authentically, he leaves nothing to doubt in sales talks. His talent as a troubleshooter is just as legendary as his technical expertise and commercial mind.

## An established team. Quick production.

"Sorry! I'm a little out of breath – but we've just been doing some heavy lifting," is how Gernot Baumgartner begins our interview with a friendly wheeze. This time it was a cable as thick as your arm which had to be transported from A to B. As the head of the department, Gernot Baumgartner joins in like everyone else on the team wherever there is work to be done. And there's never a shortage of work in his team's area.

Classic logistics, management of the incoming material and maintaining contacts between the sales team, customers and shipping companies ... that and more must be coordinated on an ongoing basis. But one thing after another. After all, everything follows an optimised workflow.

**Production**  
Welcome to the heart of our manufacturing department. This is where all of our compact panels and module panels are built. The first thing many visitors to the factory hall notice: it is relatively quiet for a production facility, very neat and surprisingly free of dust. That can be a surprise; after all, the speedy arms of the machines work around the clock cutting Fermacell fibreboards and fitting them with VarioProFile pipes. The Variotherm skirting heating systems are also produced here in a semi-automatic process. It all happens behind the plexiglass walls of the computer-controlled workbenches. Outside them, the machine administrators responsible for fitting, operating and maintenance do their work. By the way, the cutting dust is extracted with no emissions via a special device. The resulting scrap metal is collected and recycled. Every centimetre of the plant is well thought through and permits maximum performance with economical use of resources.

**Warehouse**  
An order arrives. The delivery leaves immediately. With our sophisticated warehouse logistics, there is virtually no delay. The entire warehousing system, and incoming and outgoing goods are perfectly optimised. Consignment of orders for dispatch is set up for the objective of offering our customers unrivalled delivery service. With our partnership with shipping companies, we ensure that the delivery chain for the goods remains short even after they leave our plant.

**Workshop**  
Have you ever wondered who makes the cool Variotherm exhibits? The samples and displays in the showrooms where our products are displayed for hands-on inspection are produced in the in-house workshop. Every sample is a hand-made masterpiece. Even the ducted channels are made here.

**Maintenance**  
Cleanliness, order in the operating equipment, minor repairs et cetera. What can be done with our own resources is taken care of promptly.



The team

From left to right: Robert Mader, Marco Kepler, Janusz Marciniak, Emanuel Payer, Thomas Soyka, Gernot Baumgartner, Sabine Jagschitz, Tibor Horvat, Petrea Purcariu, Renate Paul, Vasile Purcariu, Marc Joaon Dias



## P:URe environment

Sometimes failing to beat a great result in the previous year can make you happy. That was our experience with our annual rubbish collection campaign. In one hour, 14 Variotherm employees collected 100 kg of rubbish in the immediate vicinity. Happily, we were unable to beat the number collected last year!

This year, the campaign was held with the cooperation of the Leobersdorf community for the first time. How did it come about? Our employee Emanuel Payer contacted the Municipal Office with this idea. The authorities loved the plan, and offered their support spontaneously. We want to thank them for the free high-visibility vests, gloves, rubbish bags and collection and disposal of the rubbish!

## P:URe therapy



In our search for a suitable use for our wage and salary rounding donations, we discovered once again that children are little miracles. Like Philipp, who, despite his young age, has already had to endure many therapies. This summer, he will spend two weeks in Slovakia with his family.

With 200 highly-qualified employees, the ADELI Medical Center is one of the leading specialist institutes for neurology, rehabilitation therapy, physiotherapy, clinical speech therapy and intensive care.

What makes ADELI stand out is the intensity and individuality of the neuro-rehabilitation. Patients are guided through their programme of treatments by five to six therapists daily. Four to six hours a day. Six days per week.

[www.adeli-center.com](http://www.adeli-center.com)

## P:URe rescue

Around the clock, 365 days a year, over 11,000 highly-trained mountain rescue to help people in emergencies. Many take the alpine rescue services for by volunteers cost money. Maintenance of the service huts, wear and tear on significant investments every year.



volunteers throughout Austria are ready granted. But even rescue services staffed rescue tools and equipment require signi-

The Triestingtal Mountain Rescue Centre is currently being overhauled. Variotherm decided to support the construction project and provided the material for the planned wall and floor heating systems free of charge. They were installed by Variotherm employees from all departments.

## P:URe training

Continuing training is the key to personal development. We are convinced of this attitude at Variotherm, which is why we enable our employees to participate in **language, informative and personal development seminars** free of charge. We also like to visit events which inspire us to reflect. The level of interest in these events, at which spouses and partners are more than welcome, is extremely high.

We are currently interested in the new show by **Roland Düringer "We – the circumstances"**, in which the cabaret artist impresses with criticism of the system and no end of economic fundamentals. During the Climate Film Festival, we attended the inspiring documentary **"Voices of Transition"** in Cinema Paradiso in Baden, which takes a critical look at climate change, organic farming and the so-called transition cities. The verdict: worth watching. Of course, other projects are planned all the time. For example, the next summer film show will be held in our own premises – and delicious ice cream is included.



The **national KNEWLEDGE** award honours companies and organisations which distinguish themselves with particularly committed and innovative personnel development. In the category for companies with up to 100 employees, this year's award, presented by the Austrian Ministry of Science, Research and Economy, went to ... Variotherm! Of course, we are delighted to receive this high honour, as we put our concept of PU:Re training into practice directly, simply and without excessive theory.

We encourage our employees to act responsibly at all times. To make this possible, we give them a great deal of freedom in their work and in the advanced training events they attend. To promote thinking outside the box, some of them travel to Switzerland once a year to the Economic Maverick Forum for Bridge-Builders, Boundary-Breakers and Pioneers. Sonja Zwazl, President of the KNEWLEDGE Initiative and the Lower Austrian Chamber of Commerce was impressed by this "refreshingly different" philosophy: "Variotherm's personnel development approach is put into practice directly on and with people."

